

## G-MINI ROUND HANGOVER SUSPENSION

### A300626-

base number    LED Dimming    Finishes (Diamond)    Finishes (Triangle)    Finishes (Circle)    Finish Options    Shine Ring    Beam Angle Options    Cable Options

- To build a product code in our configurator select the specify button on the base model # product page
- To build a manual product code on this datasheet choose from the options listed below in blue font and add the suffix to the base model #

#### GENERAL

Series: G-Mini Round  
 Subseries: G-Mini Round Hangover  
 Partner: Prolicht  
 Division: Architectural  
 Installation: Suspension  
 Product Type: Clusters  
 Mounting Location: Ceiling  
 Light Distribution: Direct

#### PHYSICAL

Shape: Cylinder  
 Diameter (mm): 347  
 Diameter (in): 13 11/16  
 Height (mm): 150  
 Height (in): 5 7/8  
 Fixture Finish: SSR / BKV / CWI / CRY / HAB / UFT / ITA / RUA / FTG / MYG / LOD / PUS / FRO / FUP / KIA / POP / BLS / SPG / MEY / GOH / CHC / COM / ABZ / JAG / OBR / MOS / ROR  
 Accent Finish: NOF / COP / MIR / SSS  
 Fixture Material: Extruded Aluminum / Steel  
 Cable Details: 2000mm/78 3/4" / 4000mm/157 1/2" - Cable, Black, Green, Orange, Red, White

#### ELECTRICAL

Lamp Type: LED (Zhaga Standard)  
 Input Wattage (W): 26  
 Total Output Wattage (W): 23.7  
 Dimming: Tri-Mode (Non-Dimming and Phase Dimming (120Vac only) and 0-10V Dimming)  
 Driver Included: Yes  
 Driver Location: Integrated  
 Driver Type: Constant Current - Universal  
 Driver Class: Class 2  
 Input Voltage (V): 120 - 277

#### LED

Color Temperature (°K): 2700 / 3000 / 3500 / 4000  
 Max. Delivered Lumen (lm): 1614 / 1709 / 1804 / 1852  
 Nominal Lumen (lm): 1840 / 1949 / 2057 / 2112  
 CRI: >90 CRI  
 Lamp Life (hrs): 50000

#### OPTICAL

Beam Angle: 20 / 26 / 56

#### RATINGS AND CERTIFICATIONS

Certified By: Certified for North American Standards  
 IP rating: IP20



## G-MINI ROUND HANGOVER SUSPENSION

A300626-

PROJECT
TYPE
SPECIFIER
QUANTITY
DATE



A

## G-MINI ROUND HANGOVER SUSPENSION

### A300627-

base number	LED Dimming	Color Temperature	Finishes (Diamond)	Finishes (Triangle)	Finishes (Circle)	Finish Options	Shine Ring	Beam Angle Options	Cable Options
-------------	-------------	-------------------	--------------------	---------------------	-------------------	----------------	------------	--------------------	---------------

- To build a product code in our configurator select the specify button on the base model # product page
- To build a manual product code on this datasheet choose from the options listed below in blue font and add the suffix to the base model #

#### GENERAL

Series: G-Mini Round  
 Subseries: G-Mini Round Hangover  
 Partner: Prolicht  
 Division: Architectural  
 Installation: Suspension  
 Product Type: Clusters  
 Mounting Location: Ceiling  
 Light Distribution: Direct

#### PHYSICAL

Shape: Cylinder  
 Diameter (mm): 347  
 Diameter (in): 13 11/16  
 Height (mm): 300  
 Height (in): 11 13/16  
 Fixture Finish: SSR / BKV / CWI / CRY / HAB / UFT / ITA / RUA / FTG / MYG / LOD / PUS / FRO / FUP / KIA / POP / BLS / SPG / MEY / GOH / CHC / COM / ABZ / JAG / OBR / MOS / ROR  
 Accent Finish: NOF / COP / MIR / SSS  
 Fixture Material: Extruded Aluminum / Steel  
 Cable Details: 2000mm/78 3/4" / 4000mm/157 1/2" - Cable, Black, Green, Orange, Red, White

#### ELECTRICAL

Lamp Type: LED (Zhaga Standard)  
 Input Wattage (W): 26  
 Total Output Wattage (W): 23.7  
 Dimming: Tri-Mode (Non-Dimming and Phase Dimming (120Vac only) and 0-10V Dimming)  
 Driver Included: Yes  
 Driver Location: Integrated  
 Driver Type: Constant Current - Universal  
 Driver Class: Class 2  
 Input Voltage (V): 120 - 277

#### LED

Color Temperature (°K): 2700 / 3000 / 3500 / 4000  
 Max. Delivered Lumen (lm): 1614 / 1709 / 1804 / 1852  
 Nominal Lumen (lm): 1840 / 1949 / 2057 / 2112  
 CRI: >90 CRI  
 Lamp Life (hrs): 50000

#### OPTICAL

Beam Angle: 20 / 26 / 56

#### RATINGS AND CERTIFICATIONS

Certified By: Certified for North American Standards  
 IP rating: IP20



## G-MINI ROUND HANGOVER SUSPENSION

A300627-

PROJECT	_____
TYPE	_____
SPECIFIER	_____
QUANTITY	_____
DATE	_____



A

## G-MINI ROUND HANGOVER SUSPENSION

### A300628-

base number    LED Dimming    Finishes (Diamond)    Finishes (Triangle)    Finishes (Circle)    Finish Options    Shine Ring    Beam Angle Options    Cable Options

- To build a product code in our configurator select the specify button on the base model # product page
- To build a manual product code on this datasheet choose from the options listed below in blue font and add the suffix to the base model #

#### GENERAL

Series: G-Mini Round  
 Subseries: G-Mini Round Hangover  
 Partner: Prolicht  
 Division: Architectural  
 Installation: Suspension  
 Product Type: Clusters  
 Mounting Location: Ceiling  
 Light Distribution: Direct

#### PHYSICAL

Shape: Cylinder  
 Diameter (mm): 347  
 Diameter (in): 13 11/16  
 Height (mm): 450  
 Height (in): 17 11/16  
 Fixture Finish: SSR / BKV / CWI / CRY / HAB / UFT / ITA / RUA / FTG / MYG / LOD / PUS / FRO / FUP / KIA / POP / BLS / SPG / MEY / GOH / CHC / COM / ABZ / JAG / OBR / MOS / ROR  
 Accent Finish: NOF / COP / MIR / SSS  
 Fixture Material: Extruded Aluminum / Steel  
 Cable Details: 2000mm/78 3/4" / 4000mm/157 1/2" - Cable, Black, Green, Orange, Red, White

#### ELECTRICAL

Lamp Type: LED (Zhaga Standard)  
 Input Wattage (W): 26  
 Total Output Wattage (W): 23.7  
 Dimming: Tri-Mode (Non-Dimming and Phase Dimming (120Vac only) and 0-10V Dimming)  
 Driver Included: Yes  
 Driver Location: Integrated  
 Driver Type: Constant Current - Universal  
 Driver Class: Class 2  
 Input Voltage (V): 120 - 277

#### LED

Color Temperature (°K): 2700 / 3000 / 3500 / 4000  
 Max. Delivered Lumen (lm): 1614 / 1709 / 1804 / 1852  
 Nominal Lumen (lm): 1840 / 1949 / 2057 / 2112  
 CRI: >90 CRI  
 Lamp Life (hrs): 50000

#### OPTICAL

Beam Angle: 20 / 26 / 56

#### RATINGS AND CERTIFICATIONS

Certified By: Certified for North American Standards  
 IP rating: IP20

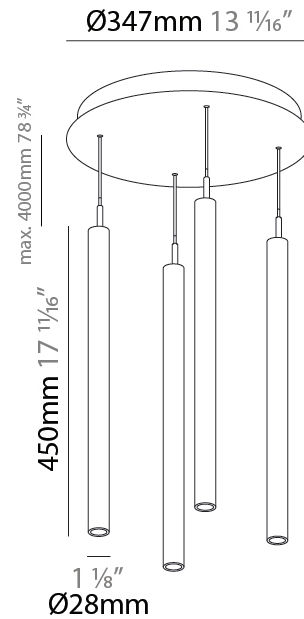
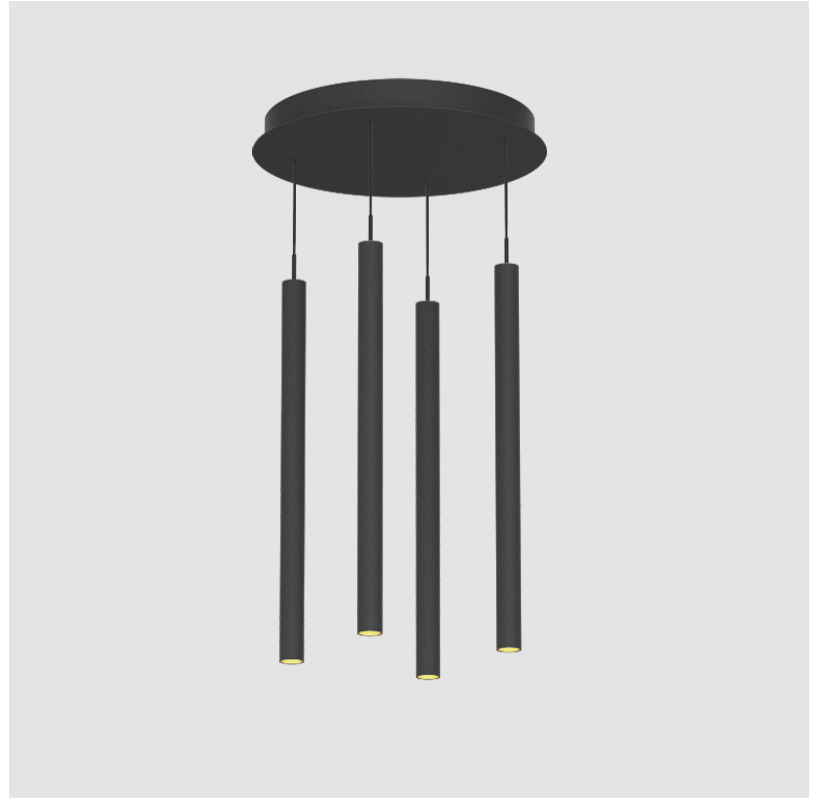

## G-MINI ROUND HANGOVER SUSPENSION

A300628-

PROJECT	_____
TYPE	_____
SPECIFIER	_____
QUANTITY	_____
DATE	_____



## G-MINI ROUND HANGOVER SUSPENSION

### A300629-

base number    LED Dimming    Finishes (Diamond)    Finishes (Triangle)    Finishes (Circle)    Finish Options    Shine Ring    Beam Angle Options    Cable Options

- To build a product code in our configurator select the specify button on the base model # product page
- To build a manual product code on this datasheet choose from the options listed below in blue font and add the suffix to the base model #

#### GENERAL

Series: G-Mini Round  
 Subseries: G-Mini Round Hangover  
 Partner: Prolicht  
 Division: Architectural  
 Installation: Suspension  
 Product Type: Clusters  
 Mounting Location: Ceiling  
 Light Distribution: Direct

#### PHYSICAL

Shape: Cylinder  
 Diameter (mm): 347  
 Diameter (in): 13 11/16  
 Height (mm): 150  
 Height (in): 5 7/8  
 Diffuser: Shine Ring - NOR / OPL / YEL / ORA / RED / BLU / GRN  
 Fixture Finish: SSR / BKV / CWI / CRY / HAB / UFT / ITA / RUA / FTG / MYG / LOD / PUS / FRO / FUP / KIA / POP / BLS / SPG / MEY / GOH / CHC / COM / ABZ / JAG / OBR / MOS / ROR  
 Accent Finish: NOF / COP / MIR / SSS  
 Fixture Material: Extruded Aluminum / Steel  
 Cable Details: 2000mm/78 3/4" / 4000mm/157 1/2" - Cable, Black, Green, Orange, Red, White

#### ELECTRICAL

Lamp Type: LED (Zhaga Standard)  
 Input Wattage (W): 26  
 Total Output Wattage (W): 23.7  
 Dimming: Non-Dimmable  
 Driver Included: Yes  
 Driver Location: Integrated  
 Driver Type: Constant Current - Universal  
 Driver Class: Class 2  
 Input Voltage (V): 120 - 277

#### LED

Color Temperature (°K): 2700 / 3000 / 3500 / 4000  
 Max. Delivered Lumen (lm): 1557 / 1421 / 1499 / 1450  
 Nominal Lumen (lm): 1840 / 1949 / 2057 / 2112  
 CRI: >90 CRI  
 Lamp Life (hrs): 50000

#### OPTICAL

Beam Angle: 32 / 58

#### RATINGS AND CERTIFICATIONS

Certified By: Certified for North American Standards  
 IP rating: IP20



## G-MINI ROUND HANGOVER SUSPENSION

A300629-

PROJECT	_____
TYPE	_____
SPECIFIER	_____
QUANTITY	_____
DATE	_____



A

## G-MINI ROUND HANGOVER SUSPENSION

### A300630-

base number    LED Dimming    Finishes (Diamond)    Finishes (Triangle)    Finishes (Circle)    Finish Options    Shine Ring    Beam Angle Options    Cable Options

- To build a product code in our configurator select the specify button on the base model # product page
- To build a manual product code on this datasheet choose from the options listed below in blue font and add the suffix to the base model #

#### GENERAL

Series: G-Mini Round  
 Subseries: G-Mini Round Hangover  
 Partner: Prolicht  
 Division: Architectural  
 Installation: Suspension  
 Product Type: Clusters  
 Mounting Location: Ceiling  
 Light Distribution: Direct

#### PHYSICAL

Shape: Cylinder  
 Diameter (mm): 347  
 Diameter (in): 13 11/16  
 Height (mm): 300  
 Height (in): 11 13/16  
 Diffuser: Shine Ring - NOR / OPL / YEL / ORA / RED / BLU / GRN  
 Fixture Finish: SSR / BKV / CWI / CRY / HAB / UFT / ITA / RUA / FTG / MYG / LOD / PUS / FRO / FUP / KIA / POP / BLS / SPG / MEY / GOH / CHC / COM / ABZ / JAG / OBR / MOS / ROR  
 Accent Finish: NOF / COP / MIR / SSS  
 Fixture Material: Extruded Aluminum / Steel  
 Cable Details: 2000mm/78 3/4" / 4000mm/157 1/2" - Cable, Black, Green, Orange, Red, White

#### ELECTRICAL

Lamp Type: LED (Zhaga Standard)  
 Input Wattage (W): 26  
 Total Output Wattage (W): 23.7  
 Dimming: Non-Dimmable  
 Driver Included: Yes  
 Driver Location: Integrated  
 Driver Type: Constant Current - Universal  
 Driver Class: Class 2  
 Input Voltage (V): 120 - 277

#### LED

Color Temperature (°K): 2700 / 3000 / 3500 / 4000  
 Max. Delivered Lumen (lm): 1557 / 1421 / 1499 / 1450  
 Nominal Lumen (lm): 1840 / 1949 / 2057 / 2112  
 CRI: >90 CRI  
 Lamp Life (hrs): 50000

#### OPTICAL

Beam Angle: 32 / 58

#### RATINGS AND CERTIFICATIONS

Certified By: Certified for North American Standards  
 IP rating: IP20

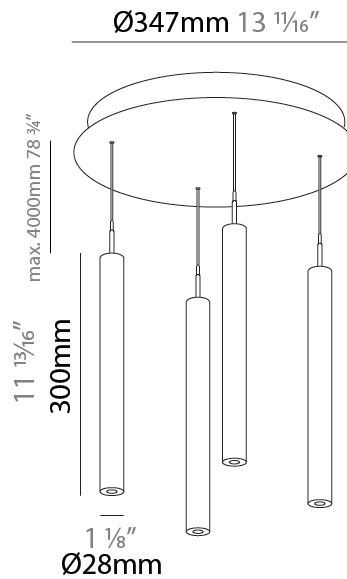

## G-MINI ROUND HANGOVER SUSPENSION

A300630-

PROJECT	_____
TYPE	_____
SPECIFIER	_____
QUANTITY	_____
DATE	_____



A

## G-MINI ROUND HANGOVER SUSPENSION

### A300631-

base number    LED Dimming    Finishes (Diamond)    Finishes (Triangle)    Finishes (Circle)    Finish Options    Shine Ring    Beam Angle Options    Cable Options

- To build a product code in our configurator select the specify button on the base model # product page
- To build a manual product code on this datasheet choose from the options listed below in blue font and add the suffix to the base model #

#### GENERAL

Series: G-Mini Round  
 Subseries: G-Mini Round Hangover  
 Partner: Prolicht  
 Division: Architectural  
 Installation: Suspension  
 Product Type: Clusters  
 Mounting Location: Ceiling  
 Light Distribution: Direct

#### PHYSICAL

Shape: Cylinder  
 Diameter (mm): 347  
 Diameter (in): 13 11/16  
 Height (mm): 450  
 Height (in): 17 11/16  
 Diffuser: Shine Ring - NOR / OPL / YEL / ORA / RED / BLU / GRN  
 Fixture Finish: SSR / BKV / CWI / CRY / HAB / UFT / ITA / RUA / FTG / MYG / LOD / PUS / FRO / FUP / KIA / POP / BLS / SPG / MEY / GOH / CHC / COM / ABZ / JAG / OBR / MOS / ROR  
 Accent Finish: NOF / COP / MIR / SSS  
 Fixture Material: Extruded Aluminum / Steel  
 Cable Details: 2000mm/78 3/4" / 4000mm/157 1/2" - Cable, Black, Green, Orange, Red, White

#### ELECTRICAL

Lamp Type: LED (Zhaga Standard)  
 Input Wattage (W): 26  
 Total Output Wattage (W): 23.7  
 Dimming: Non-Dimmable  
 Driver Included: Yes  
 Driver Location: Integrated  
 Driver Type: Constant Current - Universal  
 Driver Class: Class 2  
 Input Voltage (V): 120 - 277

#### LED

Color Temperature (°K): 2700 / 3000 / 3500 / 4000  
 Max. Delivered Lumen (lm): 1557 / 1421 / 1499 / 1450  
 Nominal Lumen (lm): 1840 / 1949 / 2057 / 2112  
 CRI: >90 CRI  
 Lamp Life (hrs): 50000

#### OPTICAL

Beam Angle: 32 / 58

#### RATINGS AND CERTIFICATIONS

Certified By: Certified for North American Standards  
 IP rating: IP20

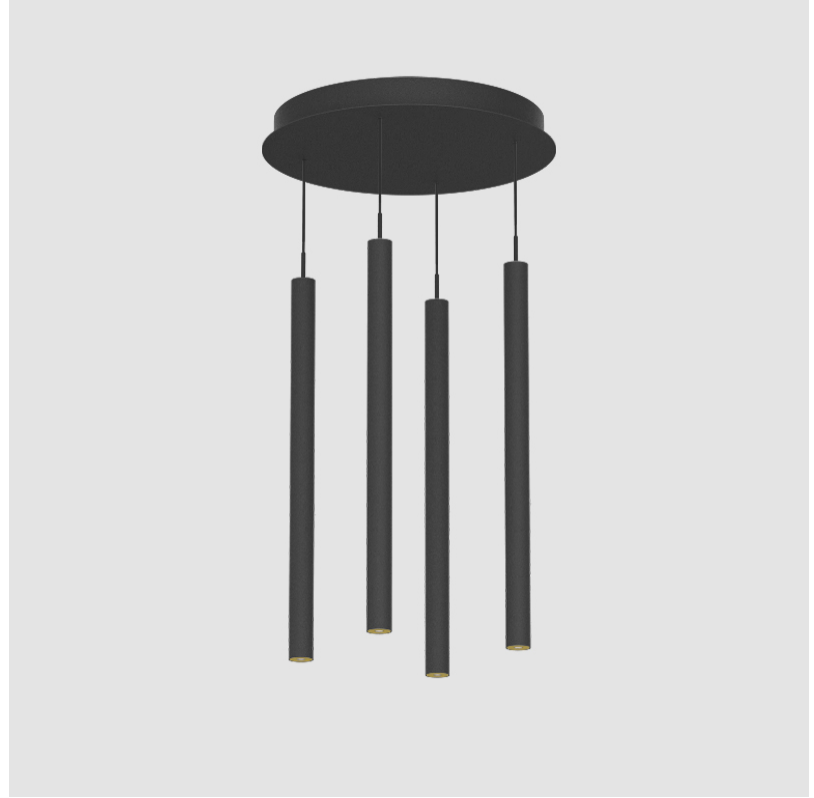

## G-MINI ROUND HANGOVER SUSPENSION

A300631-

PROJECT
TYPE
SPECIFIER
QUANTITY
DATE

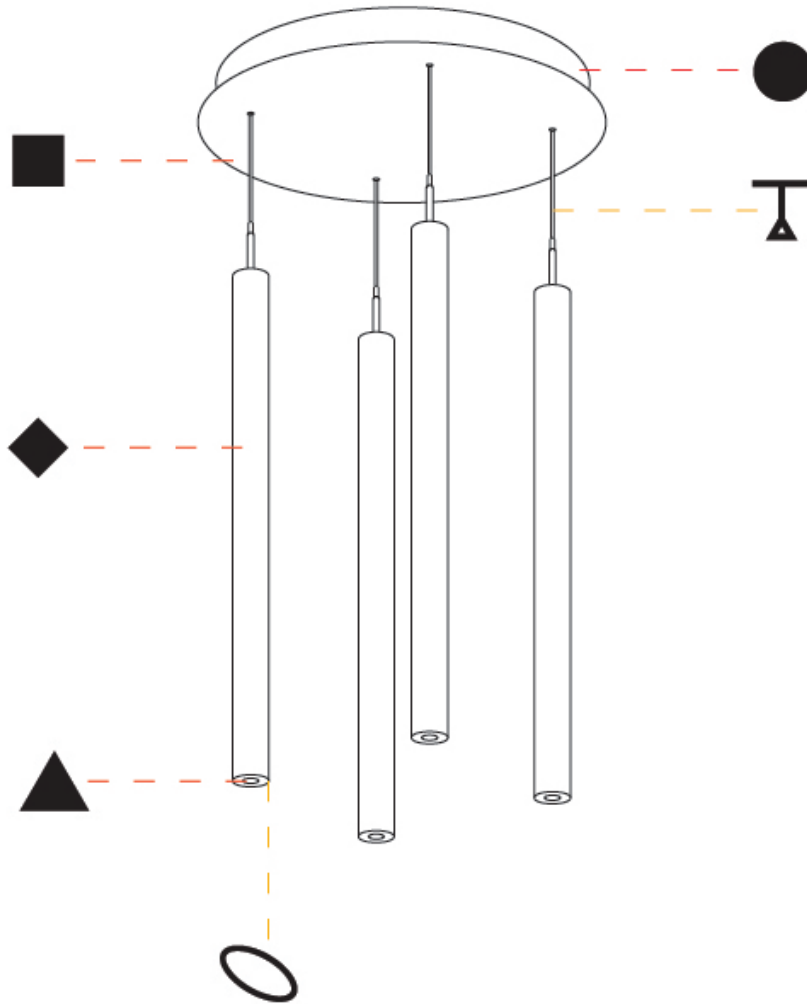

A

## G-MINI ROUND HANGOVER SUSPENSION

### A300635-

base number    LED Dimming    Finishes (Diamond)    Finishes (Triangle)    Finishes (Circle)    Finish Options    Shine Ring    Beam Angle Options    Cable Options

- To build a product code in our configurator select the specify button on the base model # product page
- To build a manual product code on this datasheet choose from the options listed below in blue font and add the suffix to the base model #

#### GENERAL

Series: G-Mini Round  
 Subseries: G-Mini Round Hangover  
 Partner: Prolicht  
 Division: Architectural  
 Installation: Suspension  
 Product Type: Clusters  
 Mounting Location: Ceiling  
 Light Distribution: Direct

#### PHYSICAL

Shape: Cylinder  
 Diameter (mm): 75  
 Diameter (in): 2 <sup>15</sup>/<sub>16</sub>  
 Length (mm): 1200  
 Length (in): 47 <sup>1</sup>/<sub>4</sub>  
 Height (mm): 150  
 Height (in): 5 <sup>7</sup>/<sub>8</sub>

Diffuser: Shine Ring - NOR / OPL / YEL / ORA / RED / BLU / GRN  
 Fixture Finish: SSR / BKV / CWI / CRY / HAB / UFT / ITA / RUA / FTG / MYG / LOD / PUS / FRO / FUP / KIA / POP / BLS / SPG / MEY / GOH / CHC / COM / ABZ / JAG / OBR / MOS / ROR  
 Accent Finish: NOF / COP / MIR / SSS  
 Fixture Material: Extruded Aluminum / Steel  
 Cable Details: 2000mm/78 3/4" / 4000mm/157 1/2" - Cable, Black, Green, Orange, Red, White

#### ELECTRICAL

Lamp Type: LED (Zhaga Standard)  
 Input Wattage (W): 26  
 Total Output Wattage (W): 23.7  
 Dimming: Non-Dimmable  
 Driver Included: Yes  
 Driver Location: Integrated  
 Driver Type: Constant Current - Universal  
 Driver Class: Class 2  
 Input Voltage (V): 120 - 277

#### LED

Color Temperature (°K): 2700 / 3000 / 3500 / 4000  
 Max. Delivered Lumen (lm): 1557 / 1649 / 1740 / 1787  
 Nominal Lumen (lm): 1840 / 1949 / 2057 / 2112  
 CRI: >90 CRI  
 Lamp Life (hrs): 50000

#### OPTICAL

Beam Angle: 6 / 22 / 38

#### RATINGS AND CERTIFICATIONS

Certified By: Certified for North American Standards  
 IP rating: IP20

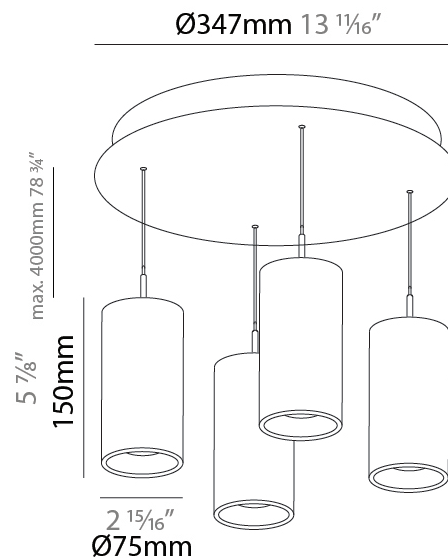

## G-MINI ROUND HANGOVER SUSPENSION

A300635-

PROJECT	_____
TYPE	_____
SPECIFIER	_____
QUANTITY	_____
DATE	_____

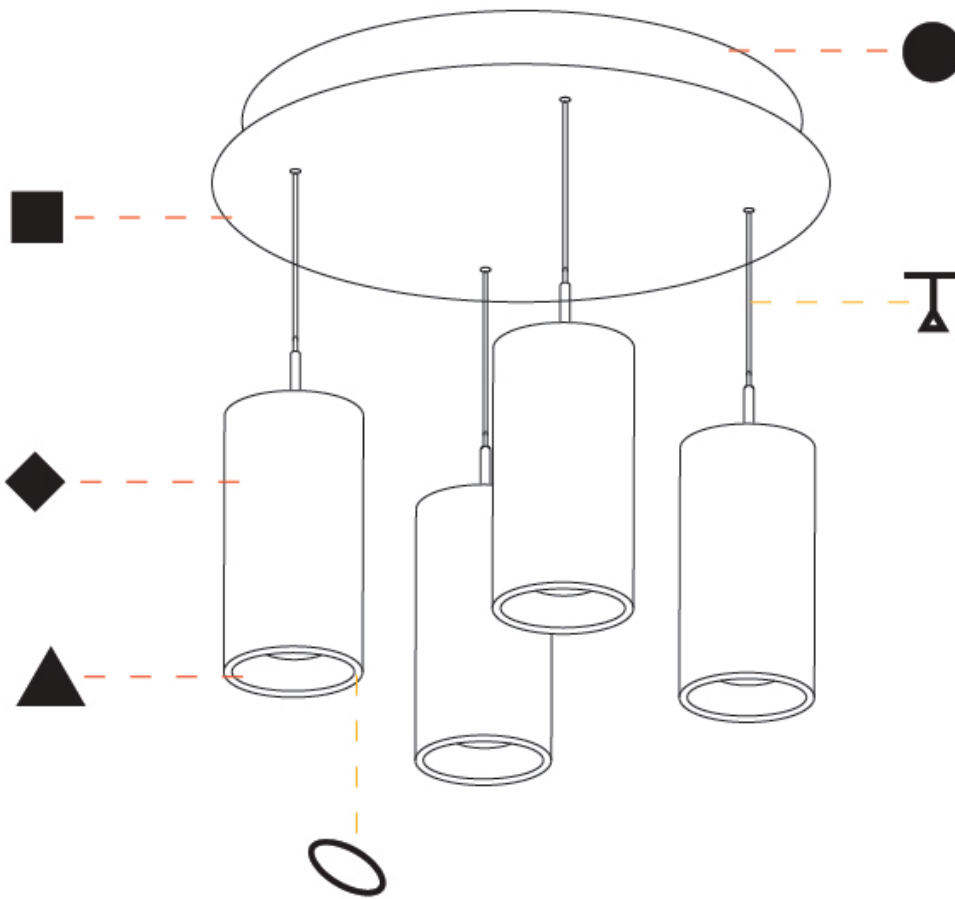

A

PROJECT	_____
TYPE	_____
SPECIFIER	_____
QUANTITY	_____
DATE	_____

## G-MINI ROUND BILO SUSPENSION

### A300646-

base number	LED Dimming	Finishes (Diamond)	Finishes (Triangle)	Finish Options	Cable Options
-------------	-------------	--------------------	---------------------	----------------	---------------

- To build a product code in our configurator select the specify button on the base model # product page
- To build a manual product code on this datasheet choose from the options listed below in blue font and add the suffix to the base model #

#### GENERAL

Series: G-Mini Round
Subseries: G-Mini Round Bilo
Partner: Prolicht
Division: Architectural
Installation: Suspension
Product Type: Clusters
Mounting Location: Ceiling
Light Distribution: Direct

#### PHYSICAL

Shape: Cylinder
Diameter (mm): 347
Diameter (in): 13 1/16
Height (mm): 120
Height (in): 4 3/4
Diffuser: Touch of Color - NOR / OPL / YEL / ORA / RED / BLU / GRN
Fixture Finish: SSR / BKV / CWI / CRY / HAB / UFT / ITA / RUA / FTG / MYG / LOD / PUS / FRO / FUP / KIA / POP / BLS / SPG / MEY / GOH / CHC / COM / ABZ / JAG / OBR / MOS / ROR
Accent Finish: NOF / COP / MIR / SSS
Fixture Material: Extruded Aluminum / Steel
Cable Details: 2000mm/78 3/4" / 4000mm/157 1/2" - Cable, Black, Green, Orange, Red, White

#### ELECTRICAL

Lamp Type: LED (Zhaga Standard)
Input Wattage (W): 26
Total Output Wattage (W): 23.7
Dimming: Tri-Mode (Non-Dimming and Phase Dimming (120Vac only) and 0-10V Dimming)
Driver Included: Yes
Driver Location: Integrated
Driver Type: Constant Current - Universal
Driver Class: Class 2
Input Voltage (V): 120 - 277

#### LED

Color Temperature (°K): 2700 / 3000 / 3500 / 4000
Max. Delivered Lumen (lm): 1424 / 1507 / 1591 / 1634
Nominal Lumen (lm): 1840 / 1949 / 2057 / 2112
CRI: >90 CRI
Lamp Life (hrs): 50000

#### OPTICAL

Beam Angle: 180
-----------------

#### RATINGS AND CERTIFICATIONS

Certified By: Certified for North American Standards
IP rating: IP20

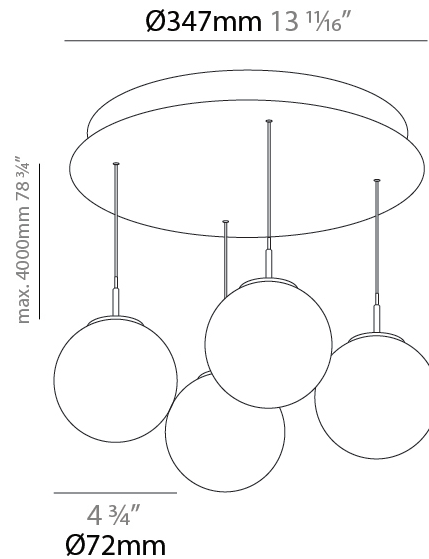

## G-MINI ROUND BILO SUSPENSION

A300646-

PROJECT	_____
TYPE	_____
SPECIFIER	_____
QUANTITY	_____
DATE	_____

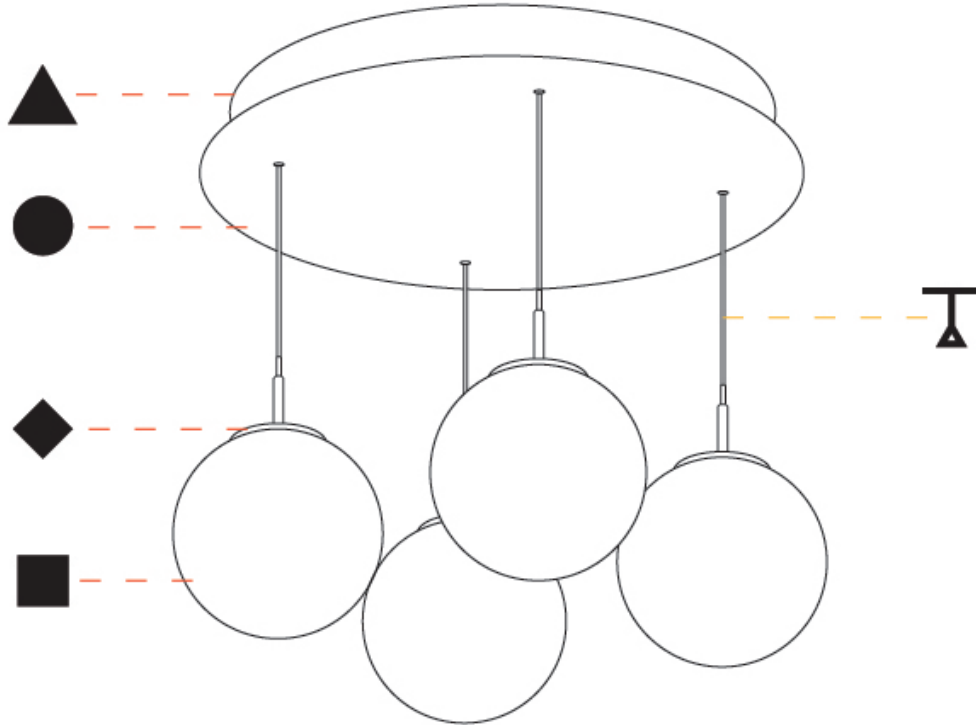

A

## G-MINI ROUND

### COLOR FINISH CHART

#### Fixture Finish

Sparkling Silver - 01 (SSR)



Black Velvet - 02 (BKV)



Crystal White - 03 (CWI)



Creamy - 04 (CRY)



Hampton Bay - 05 (HAB)



Urban Forest - 07 (UFT)



In the Army - 08 (ITA)

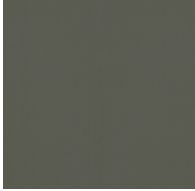

Rusty Angel - 09 (RUA)



Fade to Gray - 12 (FTG)



Mysterious Gray - 13 (MYG)

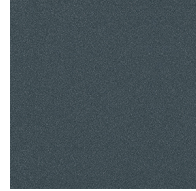

Lost Dream - 15 (LOD)



Purple Sky - 16 (PUS)



Fresh Oh - 17 (FRO)

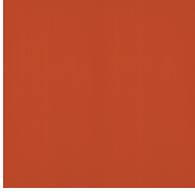

Funky P. - 18 (FUP)



Kissing Aphrodite - 19 (KIA)



Poseidon's Paradise - 20 (POP)

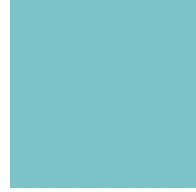

Blue Sky - 21 (BLS)



Spring Green - 22 (SPG)

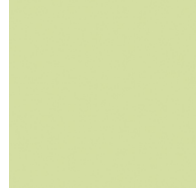

Mellow Yellow - 23 (MEY)

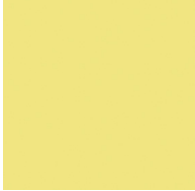

Golden Heart - 24 (GOH)

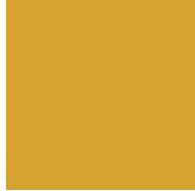

Champagne Cream - 26 (CHC)



Copper Mine - 27 (COM)



Ancient Bronze - 28 (ABZ)



Jazz Gold - 29 (JAG)



Olive Breeze - 30 (OBR)



Moonlight Silver - 31 (MOS)



Rosewood Red - 32 (ROR)



## G-MINI ROUND BILO, G-MINI ROUND HANGOVER SUSPENSION COLOR FINISH CHART

PROJECT \_\_\_\_\_

TYPE \_\_\_\_\_

SPECIFIER \_\_\_\_\_

QUANTITY \_\_\_\_\_

DATE \_\_\_\_\_

### Accent Finish

Copper - 51 (COP)

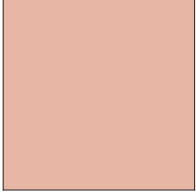

Mirror - 53 (MIR)



**Digital:** Not all screens are calibrated the same, and therefore, colors will appear differently between screens.

**Physical:** When texture is involved, there will be variations in color, character and tone within a product series and between product families.

**Champagne Cream, Copper Mine, Ancient Bronze + Jazz Gold:** These finishes have slight fading from specific powder coating production. Each luminaire will slightly vary.



### LEGEND

	floor-mounted		pivotable		special LED (upon request) RGB, RGBW, tunable, gold+, meat+, art+, fashion+
	wall and ceiling: recessed and surface mounted		rotating		warm dim / natural dimming LED
	ceiling-mounted and wall-mounted		illuminate tilted		rechargeable battery powered
	wall-mounted		color of suspension cable		fixture with natural vivid LED (upon request)
	omni-directional light distribution		length of suspension cable		color rendering index
	direct light distribution		reflector degree selection		color temperature
	direct/indirect light distribution		super spot		lumen (luminous flux)
	indirect light distribution		lens		efficacy (lumens per watt)
	asymmetric light distribution		lens pack		Unified Glare Rating (UGR) range from 5-40
	aura light distribution		shine ring		marine grade (AISI 316 stainless steel)
	round wall or ceiling cut-out		integrated shine ring with diffuser		walk on
	square wall or ceiling cut-out		free individual colors 01-29		drive on
	the supplied jig specifies the cutout dimensions		individual colors: 00 (free of charge), 01-25 (extra charge)		Dark Sky Compliance
	minimum distance (meters) lamp - object		luminaire part to be colored (F1)		Americans with Disabilities Act (less than 4" off the wall located between 27"-84" from floor)
	recessed depth		luminaire part to be colored (F2)		lamp protected against explosion
	ceiling thickness in mm		luminaire part to be colored (F3)		blown glass using traditional methods by master glass blower
	ceiling thickness selection		luminaire part to be colored (F4)		acoustic material
	dimnable DP (phase), DV (0-10V), DD (dali), DS (step-dim)		luminaire part to be colored (F5)		protection class I, protection insulation
	included or excluded LED driver/transformer/control gear		color of 3-circuit adaptor		protection class II, protection insulation
	separately switchable		indirect diffuser		ETL Certified to UL and CSA Standards
	sensor		direct diffuser		UL Certified to UL and CSA Standards
	remote control		ball-proof (upon request)		CSA Certified to UL and CSA Standards
	available upon request		accessory		Certified for North American Standards

### IP RATING

	protected against ingress of solid bodies greater than 12.5mm (finger)
	protected against ingress of solid bodies greater than 2.5mm protected against sprays of water up to 60 degrees from the vertical (rain)
	protected against ingress of solid bodies greater than 1mm (wire) no protection against the ingress of moisture
	protected against ingress of solid bodies greater than 1mm (wire) protected against sprays of water up to 60 degrees from the vertical (rain)
	protected against ingress of solid bodies greater than 1mm (wire) protected against water splashed from all directions
	protected against limited ingress of dust (wet rooms/covered outdoor areas) protected against water splashed from all directions
	protected against ingress of dust protected against jets of water
	protected against ingress of dust protected against powerful jets of water or heavy seas
	protected against ingress of dust protected against immersion of water between 15cm - 1m for 30 minutes
	protected against ingress of dust protected against immersion of water under pressure for long periods

### IK RATING

	protected against 0.14 joules impact (equivalent to 0.25kg mass dropped from 56mm above the surface)
	protected against 0.2 joules impact (equivalent to 0.25kg mass dropped from 80mm above the surface)
	protected against 0.35 joules impact (equivalent to 0.25kg mass dropped from 140mm above the surface)
	protected against 0.5 joules impact (equivalent to 0.25kg mass dropped from 200mm above the surface)
	protected against 0.7 joules impact (equivalent to 0.25kg mass dropped from 280mm above the surface)
	protected against 1 joules impact (equivalent to 0.25kg mass dropped from 400mm above the surface)
	protected against 2 joules impact (equivalent to 0.5kg mass dropped from 400mm above the surface)
	protected against 5 joules impact (equivalent to 1.7kg mass dropped from 300mm above the surface)
	protected against 10 joules impact (equivalent to 5.0kg mass dropped from 200mm above the surface)
	protected against 20 joules impact (equivalent to 5.0kg mass dropped from 400mm above the surface)